

# TEST REPORT

Report No..... : ZHT-240529026E  
Product..... : Servo Driver  
Trademark..... : **XINJE**  
Model(s)..... : Detailed model information can be found in Chapter 3.2  
Applicant..... : Wuxi Xinje Electric Co., Ltd.  
Address..... : No.816, Jianzhu West Road, Binhu District, Wuxi City, Jiangsu Province, China  
Manufacturer..... : Wuxi Xinje Electric Co., Ltd.  
Address..... : No.816, Jianzhu West Road, Binhu District, Wuxi City, Jiangsu Province, China  
Prepared by..... : Guangdong Zhonghan Testing Technology Co., Ltd.  
Address..... : Room 104, Building 1, Yibaolai Industrial Park, Qiaotou Community, Fuhai Street, Bao'an District, Shenzhen, Guangdong, China  
Date of Receipt..... : May 29, 2024  
Date of Test(s)..... : This report does not include tests.  
Date of Issue..... : May 31, 2024  
Test Standard(s)..... : EN IEC 61800-3:2018  
EN 61000-3-12:2011  
EN IEC 61000-3-11:2019

In the configuration tested, the EUT complied with the standards specified above.

Tested by:

*Kimi Lu*

Kimi Lu/ Engineer

Reviewed by:

*Baret Wu*

Baret Wu/ Director



**Note:** The results shown in this test report refer only to the sample(s) tested unless otherwise stated. This test report shall not be reproduced except in full, without prior written approval of ZHT. This document may be altered or revised by ZHT, personnel only, and shall be noted in the revision of the document.



## Table of Contents

1. Revision History .....	3
2. Test Summary .....	4
3. General Information .....	5
3.1. Description of EUT .....	5
3.2. Model List .....	6
3.3. Block diagram of EUT configuration .....	7
3.4. Test Mode .....	7
3.5. Test Site Environment .....	8
4. Facilities .....	9
4.1. Test Facility .....	9
4.2. Test Instruments .....	9
4.3. Testing software .....	9
4.4. Measurement uncertainty .....	9
5. Emission .....	10
5.1. Conducted Emission .....	10
5.2. Radiated emissions .....	14
5.3. Harmonic current emissions .....	18
5.4. Voltage changes, voltage fluctuations and flicker .....	19
6. Immunity .....	20
6.1. Electrostatic discharges .....	21
6.2. Radio-frequency electromagnetic fields .....	23
6.3. Fast transients .....	25
6.4. Surges .....	28
6.5. Injected currents .....	30
6.6. Power frequency magnetic fields .....	32
6.7. Voltage dips and interruptions .....	33
7. Photographs of EUT .....	35



### 1. Revision History

Report No.	Issue Date	Description	Approved
ZHT-240529026E	May 31, 2024	Original	Valid

This testing report adds models on the basis of ZHT-230925049E. Adding models will not affect the test results. No further testing is required for EUT. All test data is based on the original report ZHT-230925049E.



## 2. Test Summary

Emission			
Requirement - Test	Test Method	Limit	Result
Conducted Emission	EN IEC 61800-3:2018	Class A	PASS
Radiated Emission	EN IEC 61800-3:2018	Class A	PASS
Immunity			
Requirement - Test	Test Method	Performance criteria	Result
Electrostatic discharges	EN 61000-4-2:2009	B	PASS
Radio-frequency electromagnetic fields	EN 61000-4-3:2020	A	PASS
Fast transients	EN 61000-4-4:2012	B	PASS
Surges	EN 61000-4-5:2014	B	PASS
Injected currents	EN 61000-4-6:2014	A	PASS
Power frequency magnetic fields	EN 61000-4-8:2010	A	N/A
Voltage dips and short interruptions	EN 61000-4-11:2020	A & C & C & C & C	PASS

Requirement - Test	Test Method	Limit	Result
Harmonic current emissions	EN 61000-3-12:2011	Class A	PASS
Voltage changes, voltage fluctuations and flicker	EN IEC 61000-3-11:2019	Clause 5	PASS

Remark: N/A is abbreviation for Not Applicable.



### 3. General Information

#### 3.1. Description of EUT

Product:	Servo Driver
Model Name:	DS5L2-20P7-PTA
Model Difference:	Only the model names are different
Rated Power Supply:	Input: AC 200~240V, 50/60Hz
Normal Testing Voltage:	AC 230 V/50 Hz
DC Line	/
I/O Ports	Refer to User Manual
Highest Frequency Generated	Below 108 MHz

Note:

1) Other Accessory Device List and Details

Description	Manufacturer	Model	Note

2) The above EUT information is declared by manufacturer and for more detailed features description, please refer to the manufacturer's specifications or the User's Manual.



### 3.2. Model List

DS5L2-20P7-PTA

DS5L1-21P5-PTA-FH, DS5L2-20P1-PTA, DS5L2-20P2-PTA, DS5L2-20P4-PTA, DS5C1-20P4-PTA-FH, DS5C1-20P7-PTA-FH, DS5C1-20P4-PTB, DS5C2-20P4-PTA, DS5C2-20P7-PTA, DS5K1-20P1-PTA, DS5K1-20P2-PTA, DS5K1-20P4-PTA, DS5K1-20P7-PTA, DM5C-23P0-R, DM5C-22P0-R, DM5C-20P4-M, DM5C-20P4-MS, DM5C-20P7-M, DM5C-20P7-MS, DM5C-21P5S-MS, DM5C-21P5S-M, DS5C5-20P4-PTA, DS5C5-20P7-PTA, DS5C5-21P0-PTA, DS5C5-21P5-PTA, DS5C5-22P3-PTA, DS5C5-22P6-PTA, DS5L2-21P0-PTA, DS5L2-21P5-PTA, DS5L2-22P3-PTA, DS5L2-22P6-PTA, DS5C2-21P0-PTA, DS5C2-21P5-PTA, DS5C2-22P3-PTA, DS5C2-22P6-PTA, DS5K1-21P0-PTA, DS5K1-21P5-PTA, DS5K1-22P3-PTA, DS5K1-22P6-PTA, DS5C1-21P5-PTA-FH, DS5C2-20P1-PTA, DS5C2-20P2-PTA, DS5F-21P5-PTA-XXXR, DS5P-21P0-PTA, DS5P-21P5-PTA, DS5P-22P3-PTA, DS5P-22P6-PTA, DS5C1-20P1-PTA-FH, DS5C1-20P2-PTA-FH, DS5C1-21P0-PTA-FH, DS5C1-22P3-PTA-FH, DS5C1-22P6-PTA-FH, DS5L1-20P1-PTA-FH, DS5L1-20P2-PTA-FH, DS5L1-20P4-PTA-FH, DS5L1-20P7-PTA-FH, DS5L1-21P0-PTA-FH, DS5L1-22P3-PTA-FH, DS5L1-22P6-PTA-FH, DS5K2-20P7-PTA, DS5K2-20P4-PTA, DS5K2-20P1-PTA, DS5K2-20P2-PTA, DS5C2-20P1-PTA-FS, DS5C2-20P2-PTA-FS, DS5C2-20P4-PTA-FS, DS5C2-20P7-PTA-FS, DS5P-20P1-PTA-FH, DS5P-20P2-PTA-FH, DS5P-20P4-PTA-FH, DS5P-20P7-PTA-FH, DS5P-21P0-PTA-FH, DS5P-21P5-PTA-FH, DS5P-22P3-PTA-FH, DS5P-22P6-PTA-FH, DS5C2-21P0-PTA-FS, DS5C2-21P5-PTA-FS, DS5C2-22P3-PTA-FS, DS5C2-22P6-PTA-FS, DS5K2-21P5-PTA, DS5K2-21P0-PTA, DS5K2-22P3-PTA, DS5K2-22P6-PTA, DS5N-22P6-PTA, DS5F-20P7-2A, DS5N-21P5-PTA, DS6F-20P7-PTA, DS6F-20P7-PTA, DS5C1S-20P1-PTA, DS5C1S-20P4-PTA, DS5C1S-20P7-PTA, DS5C1S-21P0-PTA, DS5C1S-21P5-PTA, DS5L1S-20P1-PTA, DS5L1S-20P2-PTA, DS5L1S-20P4-PTA, DS5L1S-20P7-PTA, DS5L1S-21P0-PTA, DS5L1S-21P5-PTA, DS5L1S-20P4-PTA(SJ)



### 3.3. Block diagram of EUT configuration

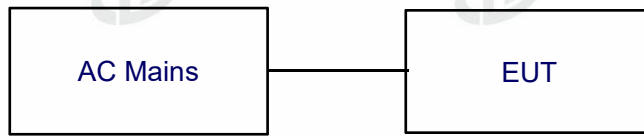

### 3.4. Test Mode

Pretest mode	Mode 1: Working mode		
Final Test mode	Conducted Emission		Mode 1
	Radiated Emission	Below 1 GHz	Mode 1
		Above 1 GHz	N/A
	Harmonic current emissions		Mode 1
	Voltage changes, voltage fluctuations and flicker		Mode 1
	Electrostatic discharges		Mode 1
	Radio-frequency electromagnetic fields		Mode 1
	Electrical fast transients/burst (EFT/B)		Mode 1
	Surges		Mode 1
	Continuous induced RF disturbances		Mode 1
	Voltage dips and short interruptions		Mode 1

**3.5. Test Site Environment**

Test Item	Required		Actual
Conducted Emission	Temperature (°C)	15-35	23.6
	Humidity (%RH)	25-75	53.8
	Barometric pressure (mbar)	860-1060	1014
Radiated Emission	Temperature (°C)	15-35	24.0
	Humidity (%RH)	25-75	54
	Barometric pressure (mbar)	860-1060	1014
Electrostatic discharges	Temperature (°C)	--	23.8
	Humidity (%RH)	--	54.5
	Barometric pressure (mbar)	--	1014
Radio-frequency electromagnetic fields	Temperature (°C)	--	23.8
	Humidity (%RH)	--	54.2
	Barometric pressure (mbar)	--	1014
Fast transients	Temperature (°C)	15-35	24.1
	Humidity (%RH)	25-75	52.2
	Barometric pressure (mbar)	860-1060	1014
Surges	Temperature (°C)	15-35	24.1
	Humidity (%RH)	25-75	52.2
	Barometric pressure (mbar)	860-1060	1014
Injected currents	Temperature (°C)	15-35	24.1
	Humidity (%RH)	25-75	52.2
	Barometric pressure (mbar)	860-1060	1014
Voltage dips and short interruptions	Temperature (°C)	15-35	24.1
	Humidity (%RH)	25-75	52.2
	Barometric pressure (mbar)	860-1060	1014
Harmonic current emissions	Temperature (°C)	15-35	24.1
	Humidity (%RH)	25-75	52.2
	Barometric pressure (mbar)	860-1060	1014
Voltage changes, voltage fluctuations and flicker	Temperature (°C)	15-35	24.1
	Humidity (%RH)	25-75	52.2
	Barometric pressure (mbar)	860-1060	1014



## 4. Facilities

### 4.1. Test Facility

This testing report adds models on the basis of ZHT-230925049E. Adding models will not affect the test results. No further testing is required for EUT. All test data is based on the original report ZHT-230925049E.

### 4.2. Test Instruments

This testing report adds models on the basis of ZHT-230925049E. Adding models will not affect the test results. No further testing is required for EUT. All test data is based on the original report ZHT-230925049E.

### 4.3. Testing software

Project	Software name	Edition
Conducted Emission	EZ-EMC	EMC-CON 3A1.1+
Radiated Emission	EZ-EMC	FA-03A2 RE+
Conducted Susceptibility	IEC/EN 61000-4-6	1.4.1
Harmonic current emissions	Harmonic	121

### 4.4. Measurement uncertainty

Where relevant, the following measurement uncertainty levels have been estimated for tests performed on the Product as specified in CISPR 16-4-2. This uncertainty represents an expanded uncertainty expressed at approximately the 95% confidence level using a coverage factor of  $k=2$ .

Test item	Value (dB)
Conducted Emission (150kHz-30MHz)	2.60
Radiated Emission(30MHz~1GHz)	4.60
Radiated Emission(1GHz~6GHz)	4.30

#### Decision Rule

- Uncertainty is not included  
 Uncertainty is included



## 5. Emission

### 5.1. Conducted Emission

#### 5.1.1. Limit

##### A.C. Mains Conducted Interference Limit

Frequency (MHz)	Class A (dBuV)		Class B (dBuV)	
	Quasi-peak	Average	Quasi-peak	Average
0.15 - 0.5	79	66	66 - 56	56 - 46
0.50 - 5.0	73	60	56	46
5.0 - 30.0	73	60	60	50

Note:

- (1) The lower limit shall apply at the transition frequencies.
- (2) The limit decreases in line with the logarithm of the frequency in the range 0.15 to 0.50 MHz.
- (3) All emanations from a class A/B digital device or system, including any network of conductors and apparatus connected thereto, shall not exceed the level of field strengths specified above.

##### Telecommunication Port Asymmetric mode Conducted Interference Limit

Requirement (MHz)	Class A Equipment				Class B Equipment			
	Voltage Limit (dB $\mu$ V)		Current Limit (dB $\mu$ A)		Voltage Limit (dB $\mu$ V)		Current Limit (dB $\mu$ A)	
	QP	Avg.	QP	Avg.	QP	Avg.	QP	Avg.
0.15 to 0.50	97 to 87	84 to 74	53 to 43	40 to 30	84 to 74	74 to 64	40 to 30	30 to 20
0.50 to 30	87	74	43	30	74	64	30	20

## 5.1.2. Test setup

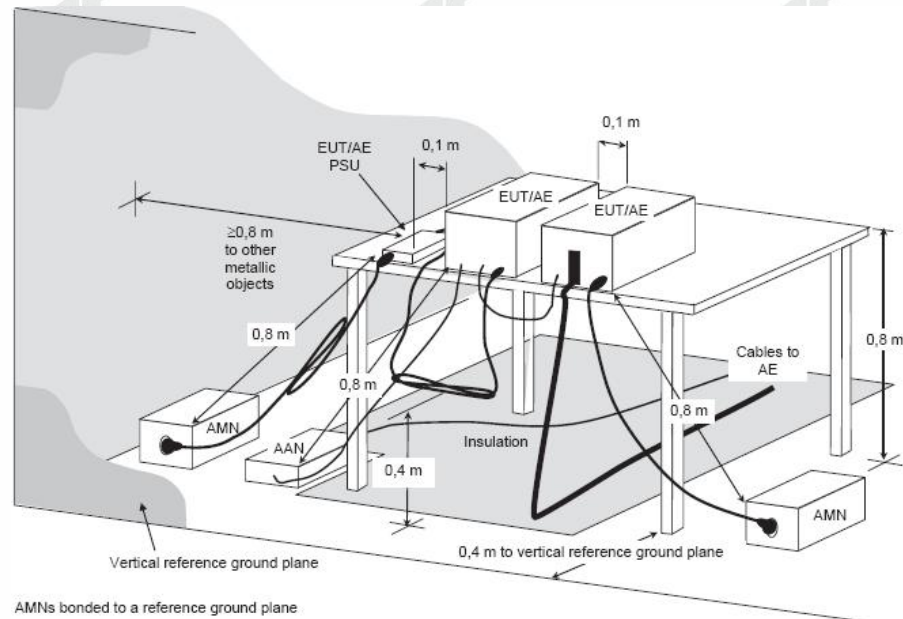

## 5.1.3. Test procedure

- The EUT was placed 0.4 meters from the conducting wall of the shielded room with EUT being connected to the power mains through a line impedance stabilization network (LISN). Other support units were connected to the power mains through another LISN. The two LISNs provide 50 Ohm/ 50uH of coupling impedance for the measuring instrument.
- Both lines of the power mains connected to the EUT were checked for maximum conducted interference.
- The test results of conducted emissions at mains ports are recorded of six worst margins for quasi-peak(mandatory) [and average (if necessary)] values against the limits at frequencies of interest unless the margin is 20 dB or greater.  
Note: The resolution bandwidth and video bandwidth of test receiver is 9kHz for quasi-peak detection (QP) and average detection (AV) at frequency 0.15MHz-30MHz.

## 5.1.4. Test results

**PASS**

Please refer to pages 12 -13 for data.



Phase: Live

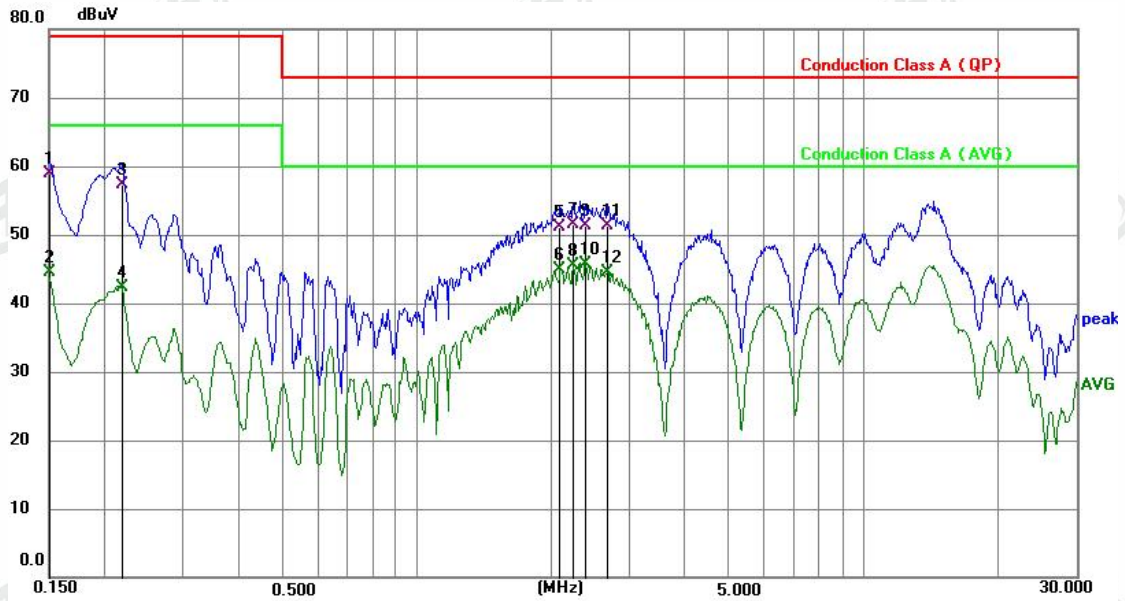

No.	Frequency (MHz)	Reading (dBuV)	Factor (dB)	Level (dBuV)	Limit (dBuV)	Margin (dB)	Detector	P/F
1	0.1500	48.97	9.89	58.86	79.00	-20.14	QP	P
2	0.1500	34.69	9.89	44.58	66.00	-21.42	AVG	P
3	0.2174	47.36	9.92	57.28	79.00	-21.72	QP	P
4	0.2174	32.47	9.92	42.39	66.00	-23.61	AVG	P
5	2.0985	40.97	10.07	51.04	73.00	-21.96	QP	P
6	2.0985	34.84	10.07	44.91	60.00	-15.09	AVG	P
7	2.2470	41.35	10.07	51.42	73.00	-21.58	QP	P
8	2.2470	35.41	10.07	45.48	60.00	-14.52	AVG	P
9	2.3864	41.27	10.07	51.34	73.00	-21.66	QP	P
10 *	2.3864	35.62	10.07	45.69	60.00	-14.31	AVG	P
11	2.6700	41.31	10.07	51.38	73.00	-21.62	QP	P
12	2.6700	34.52	10.07	44.59	60.00	-15.41	AVG	P



Phase: Neutral

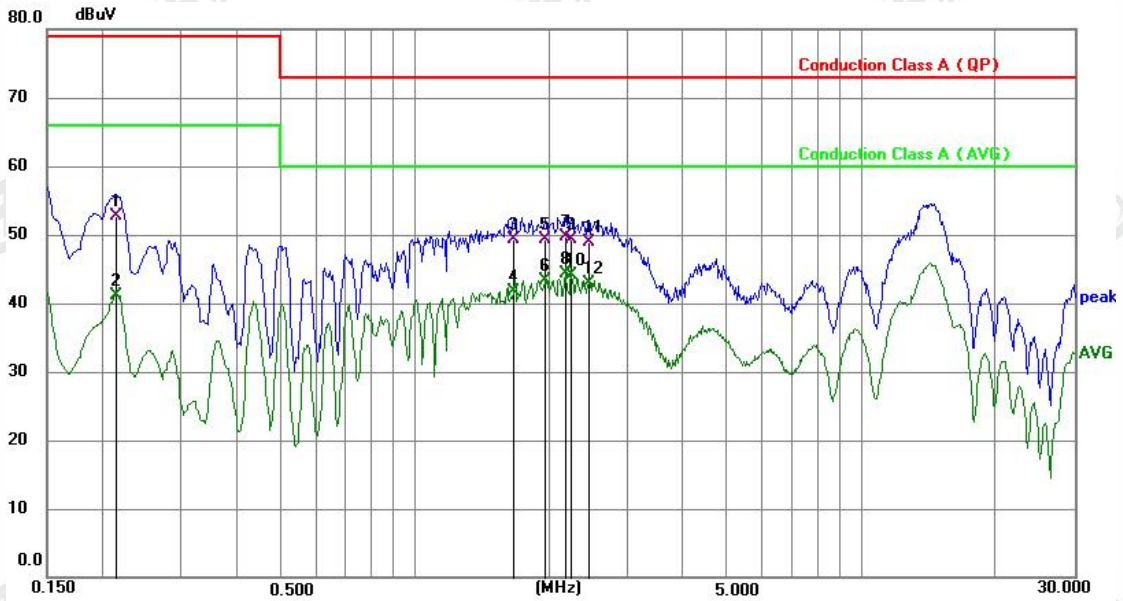

No.	Frequency (MHz)	Reading (dBuV)	Factor (dB)	Level (dBuV)	Limit (dBuV)	Margin (dB)	Detector	P/F
1	0.2130	42.86	9.92	52.78	79.00	-26.22	QP	P
2	0.2130	31.27	9.92	41.19	66.00	-24.81	AVG	P
3	1.6710	39.20	10.06	49.26	73.00	-23.74	QP	P
4	1.6710	31.71	10.06	41.77	60.00	-18.23	AVG	P
5	1.9590	39.33	10.06	49.39	73.00	-23.61	QP	P
6	1.9590	33.26	10.06	43.32	60.00	-16.68	AVG	P
7	2.1705	39.65	10.07	49.72	73.00	-23.28	QP	P
8 *	2.1705	34.18	10.07	44.25	60.00	-15.75	AVG	P
9	2.2380	39.16	10.07	49.23	73.00	-23.77	QP	P
10	2.2380	34.01	10.07	44.08	60.00	-15.92	AVG	P
11	2.4495	38.92	10.07	48.99	73.00	-24.01	QP	P
12	2.4495	32.86	10.07	42.93	60.00	-17.07	AVG	P

Note: Level=Reading + Factor  
 Margin=Level – Limit



### 5.2. Radiated emissions

#### 5.2.1. Limit

Frequency (MHz)	dBuV/m (Distance 3m)
30 ~ 230	50
230 ~ 1000	57

#### 5.2.2. Block diagram of test setup

##### Measurement distance

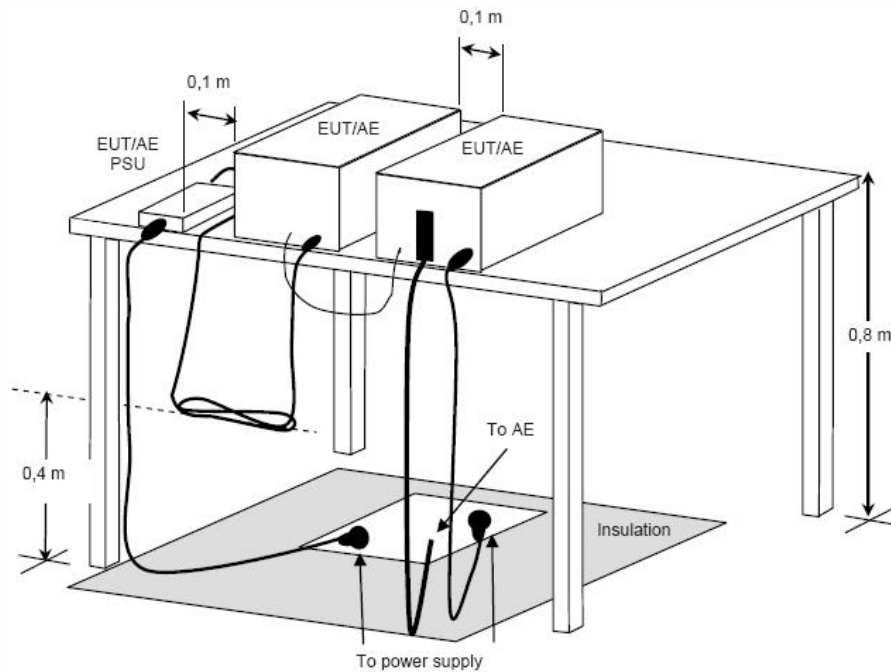
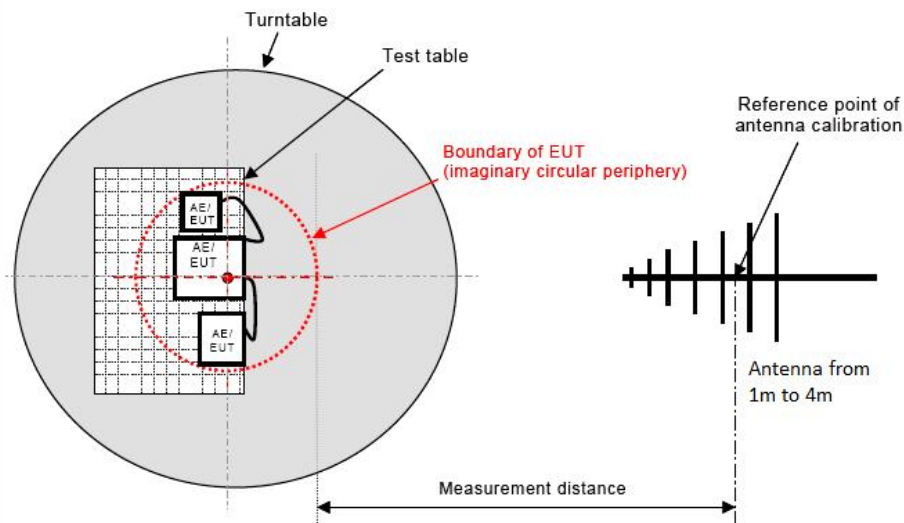

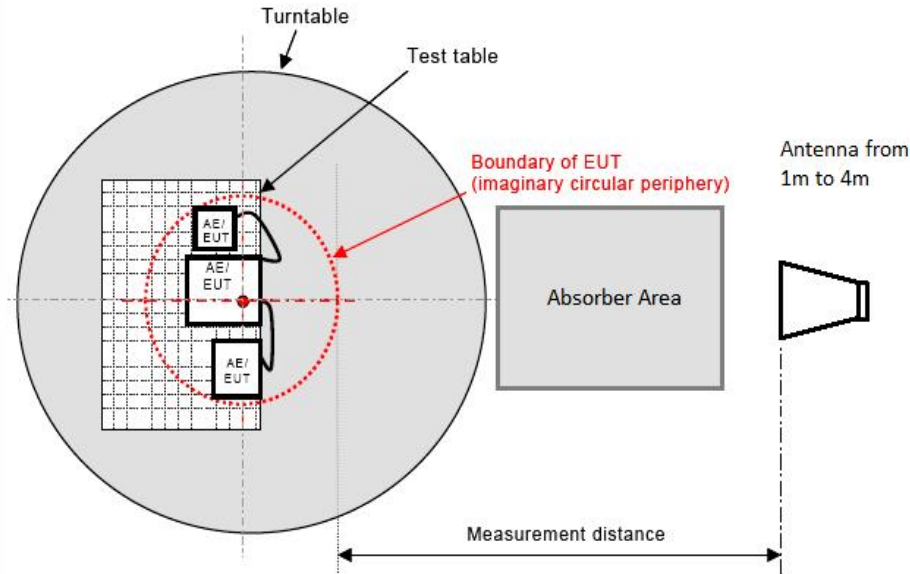

### 5.2.3. Test procedure

- The EUT was placed on the top of a rotating table 0.8 meters above the ground at a 3 meter semi-anechoic chamber room. The table was rotated 360 degrees to determine the position of the highest radiation.
- The EUT was set 3 meters away from the interference-receiving antenna, which was mounted on the top of a variable-height antenna tower.
- The height of antenna is varied from 1 meter to 4 meters above the ground to determine the maximum value of the field strength. Both horizontal and vertical polarizations of the antenna are set to make the measurement.
- For each suspected emission, the EUT was arranged to its worst case and then the antenna was tuned to heights from 1 meter to 4 meters and the rotatable table was turned from 0 degrees to 360 degrees to find the maximum reading.
- The test-receiver system was set to quasi-peak detect function and specified bandwidth with maximum hold mode when the test frequency is below 1GHz.

### 5.2.4. Test results

**PASS**

Please refer to pages 16 -17 for data.



Polarization: Horizontal

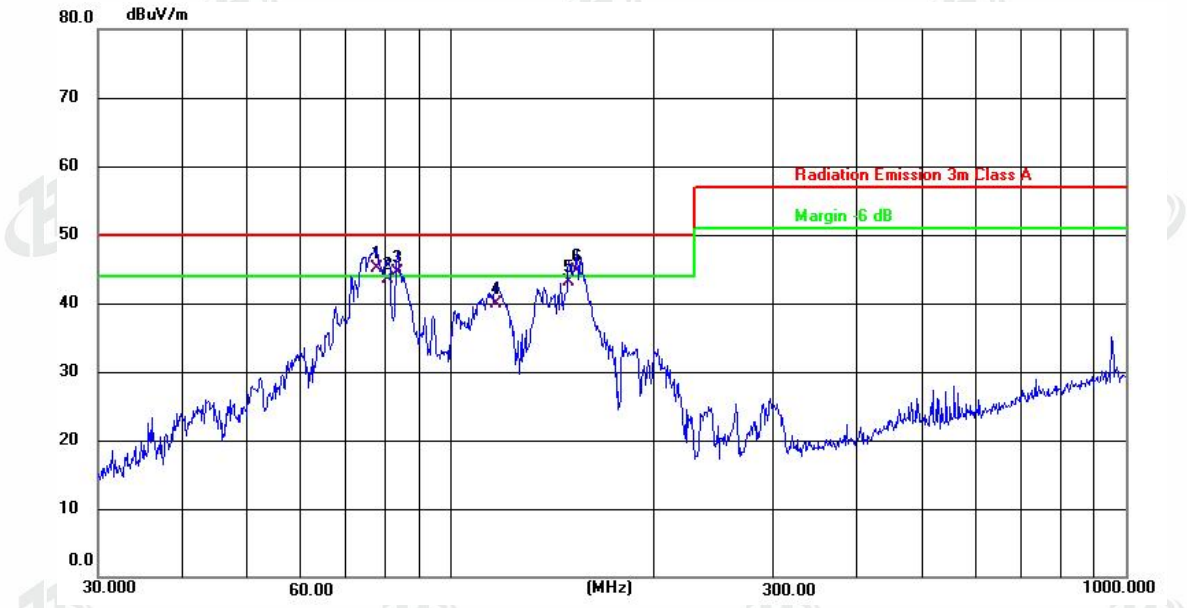

No.	Frequency (MHz)	Reading (dBuV)	Factor (dB/m)	Level (dBuV/m)	Limit (dBuV/m)	Margin (dB)	Detector
1 *	77.5926	58.71	-13.62	45.09	50.00	-4.91	QP
2	80.6440	57.29	-13.86	43.43	50.00	-6.57	QP
3 !	83.2296	57.99	-13.42	44.57	50.00	-5.43	QP
4	116.5400	52.20	-12.31	39.89	50.00	-10.11	QP
5	149.4857	56.98	-13.89	43.09	50.00	-6.91	QP
6 !	153.7384	58.33	-13.68	44.65	50.00	-5.35	QP



Polarization: Vertical

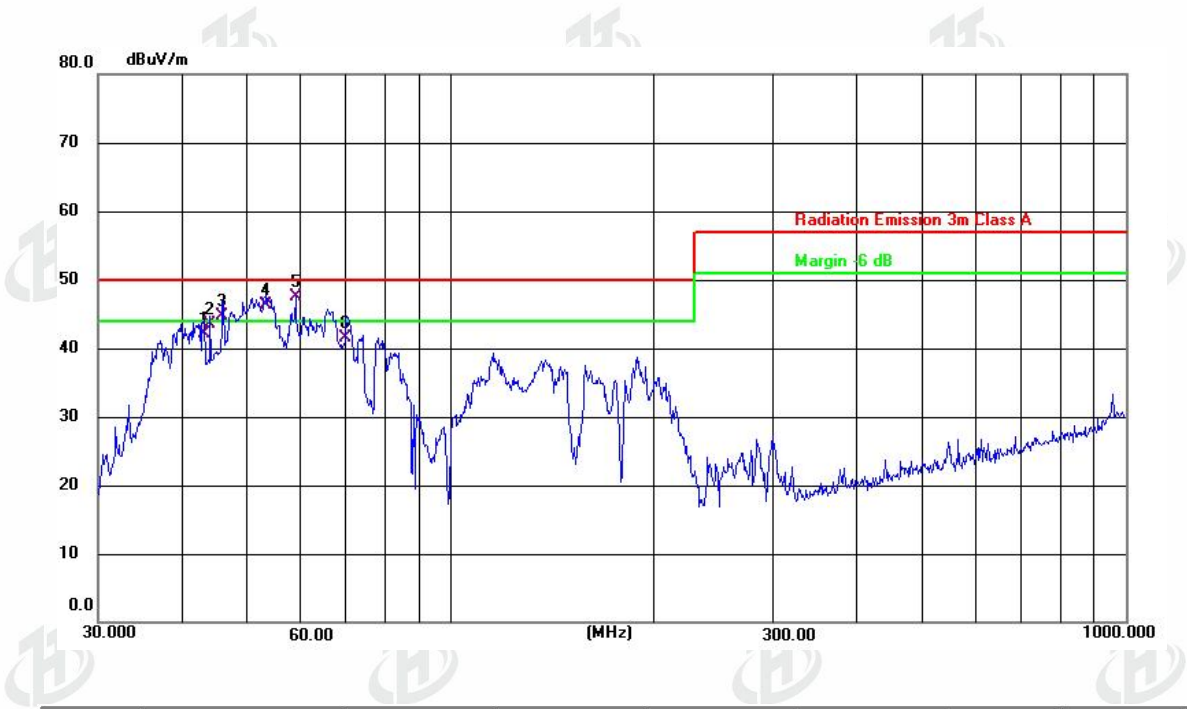

No.	Frequency (MHz)	Reading (dBuV)	Factor (dB/m)	Level (dBuV/m)	Limit (dBuV/m)	Margin (dB)	Detector
1	43.0504	50.96	-8.94	42.02	50.00	-7.98	QP
2	43.9658	52.39	-8.87	43.52	50.00	-6.48	QP
3 !	45.8551	53.39	-8.74	44.65	50.00	-5.35	QP
4 !	53.1313	54.91	-8.68	46.23	50.00	-3.77	QP
5 *	58.8185	56.61	-9.13	47.48	50.00	-2.52	QP
6	69.8450	54.01	-12.44	41.57	50.00	-8.43	QP

Note: Level=Reading + Factor

Margin=Level – Limit



### 5.3. Harmonic current emissions

#### 5.3.1. Test Procedure

The EUT was placed on the top of a wooden table 0.8 meters above the ground and the EUT is supplied in series with power analyzer from a power source having the same normal voltage and frequency as the rated supply voltage and the equipment under test. And the rated voltage at the supply voltage of EUT of 0.94 times and 1.06 times shall be performed.

A definition of the normal load or of the conditions for adequate heat discharge can usually be found in the EN publication corresponding to the equipment under test.

Equipment may have several separately controlled circuits. Each circuit is considered as a single piece of equipment if it can be operated independently and separately from the other circuits.

#### 5.3.2. Limit

Current emission limits for equipment other than balanced three-phase equipment

Minimum $R_{sce}$	Admissible individual harmonic current $I_h/I_{ref}$ <sup>a</sup> %						Admissible harmonic parameters %	
	$I_3$	$I_5$	$I_7$	$I_9$	$I_{11}$	$I_{13}$	$THC/I_{ref}$	$PWHC/I_{ref}$
33	21,6	10,7	7,2	3,8	3,1	2	23	23
66	24	13	8	5	4	3	26	26
120	27	15	10	6	5	4	30	30
250	35	20	13	9	8	6	40	40
≥350	41	24	15	12	10	8	47	47

The relative values of even harmonics up to order 12 shall not exceed  $16/h$  %. Even harmonics above order 12 are taken into account in  $THC$  and  $PWHC$  in the same way as odd order harmonics.

Linear interpolation between successive  $R_{sce}$  values is permitted.

<sup>a</sup>  $I_{ref}$  = reference current;  $I_h$  = harmonic current component.

#### 5.3.3. Test Result

**PASS**



### 5.4. Voltage changes, voltage fluctuations and flicker

#### 5.4.1. Test Procedure

The EUT is supplied in series with power analyzer from a power source having the same normal voltage and frequency as the rated supply voltage and the equipment under test. And the rated voltage at the supply voltage of EUT of 0.94 times and 1.06 times shall be performed.

The EUT was placed on the top of a wooden table 0.8 meters above the ground and operated to produce the most unfavorable sequence of voltage changes under normal operating conditions.

During the flick measurement, the measure time shall include that part of whole operation cycle in which the EUT produce the most unfavorable sequence of voltage changes. The observation period for short-term flicker indicator is 10 minutes and the observation period for long-term flicker indicator is 2 hours.

#### 5.4.2. Limit

Test Item	Limit
Pst (Short-term flicker indicator.)	1.0
Plt (Long-term flicker indicator.)	0.65
Td(t)(ms) ( Maximum time that d(t) exceeds 3.3%)	500
dmax(%) (Maximum relative voltage change.)	4
dc(%) (Relative steady-state voltage change)	3.3

#### 5.4.3. Test Result

**PASS**



## 6. Immunity

### Performance criteria

#### Performance criterion A

The equipment shall continue to operate as intended without operator intervention. No degradation of performance or loss function is allowed below a performance level specified by the manufacturer, when the equipment is used as intended. The performance level may be replaced by a permissible loss of performance. If the minimum performance level or the permissible performance loss is not specified by the manufacturer, then either of these may be derived from the product description and documentation, and by what the user may reasonably expect from the equipment if used as intended.

#### Performance criterion B

The equipment shall continue to operate as intended after the test. No degradation of performance or loss function is allowed below a performance level specified by the manufacturer, when the equipment is used as intended. During the test, degradation of performance is however allowed. No change of actual operating state or stored data is allowed. If the minimum performance level or the permissible performance loss is specified by the manufacturer, either of these may be derived from the product description and documentation and what the user may reasonably expect from equipment if used as intended.

#### Performance criterion C

Temporary loss of function is allowed, provided the function is self-recoverable or can be restored by operation of the controls.





### 6.1. Electrostatic discharges

#### 6.1.1. Test Specification

Test Port	:	Enclosure port
Discharge Impedance	:	330 ohm / 150 pF
Discharge Mode	:	Single Discharge
Discharge Period	:	one second between each discharge

#### 6.1.2. Test Levels and Performance Criterion

Test Standard

EN 55035:2017+A11:2020  
(EN 61000-4-2: 2009)

Level	Test Voltage Contact Discharge (KV)	Test Voltage Air Discharge (KV)
1.	±2	±2
2.	±4	±4
3.	±6	±8
4.	±8	±15
X	Special	Special

Performance criterion: **B**

#### 6.1.3. Test setup

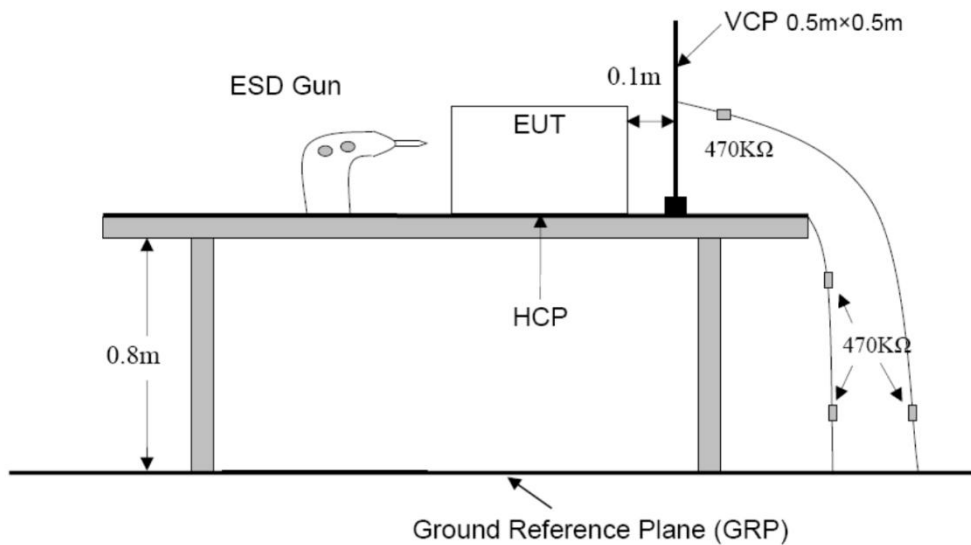



6.1.4. Test Procedure

**Air Discharge:**

This test is done on a non-conductive surface. The round discharge tip of the discharge electrode shall be approached as fast as possible to touch the EUT. After each discharge, the discharge electrode shall be removed from the EUT. The generator is then re-triggered for a new single discharge and repeated (10 of each polarity) for each pre-selected test point. This procedure shall be repeated until all the air discharge completed.

**Contact Discharge:**

All the procedure shall be same as Section Air Discharge except that the tip of the discharge electrode shall touch the EUT.

**Indirect discharge for horizontal coupling plane:**

At least 10 single discharges(in the most sensitive polarity) shall be applied at the front edge of each HCP opposite the center point of each unit(if applicable) of the EUT and 0.1m from the front of the EUT. The long axis of the discharge electrode shall be in the plane of the HCP and perpendicular to its front edge during the discharge.

**Indirect discharge for vertical coupling plane:**

At least 10 single discharge (in the most sensitive polarity) shall be applied to the center of one vertical edge of the coupling plane. The coupling plane, of dimensions 0.5m X 0.5m, is placed parallel to, and positioned at a distance of 0.1m from the EUT. Discharges shall be applied to the coupling plane, with this plane in sufficient different positions that the four faces of the EUT are completely illuminated.

6.1.5. Test Result

**PASS**

Test Point	Contact (C) Air (A)	Voltage (kV)	Performance Criterion	Result (Performance Criterion)
Indirect Discharge (HCP)	C	± 4	<input type="checkbox"/> A <input checked="" type="checkbox"/> B	A
Indirect Discharge (VCP)	C	± 4	<input type="checkbox"/> A <input checked="" type="checkbox"/> B	A
Conductive Surfaces	C	± 4	<input type="checkbox"/> A <input checked="" type="checkbox"/> B	A
Slots, Apertures, and Insulating Surfaces	A	± 8	<input type="checkbox"/> A <input checked="" type="checkbox"/> B	A

## 6.2. Radio-frequency electromagnetic fields

### 6.2.1. Test Specification

Test Port	:	Enclosure port
Step Size	:	1%
Modulation	:	1kHz, 80% AM
Dwell Time	:	1 second
Polarization	:	Horizontal & Vertical

### 6.2.2. Test Levels and Performance Criterion

Test Standard

EN 55035:2017+A11:2020

(EN 61000-4-3:2020)

Characteristics	Test levels	
Frequency range	80 MHz to 1 000 MHz, 1 400 MHz to 2 000 MHz,	2 000 MHz to 2 700 MHz
Test level	3 V/m (unmodulated)	1 V/m (unmodulated)
Modulation	1 kHz, 80 % AM, sine wave	1 kHz, 80 % AM, sine wave

Performance criterion: **A**

### 6.2.3. Test setup

For table-top equipment

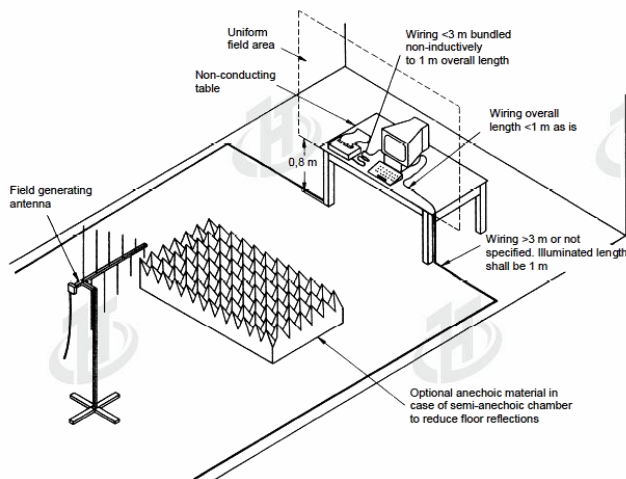

For floor standing equipment

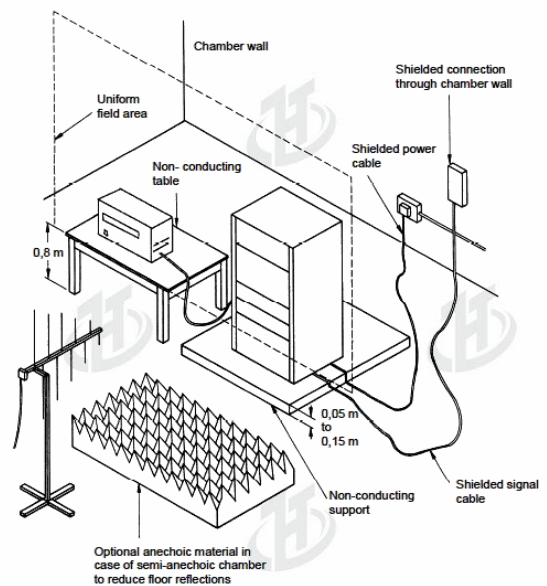



6.2.4. Test Procedure

Measurement was performed in full-anechoic chamber.  
Measurement procedure was applied according to EN 61000-4-3 clause 8.  
The test method and equipment was specified by EN 61000-4-3.

6.2.5. Test Result

**PASS**

Frequency (MHz)	Polarization	Test level (V/m)	Modulation	Exposed location	Result (Performance Criterion)
80-1 000, 1 400-2000	H & V	3	1 kHz, 80% AM, 1 % increment	All sides	A
2 000 - 2 700	H & V	1	1 kHz, 80% AM, 1 % increment	All sides	A



### 6.3. Fast transients

#### 6.3.1. Test Specification

Test Port	:	input a.c. power port
Impulse Frequency	:	5 kHz
Impulse Wave-shape	:	5/50 ns
Burst Duration	:	15 ms
Burst Period	:	300 ms
Test Duration	:	2 minutes per polarity

#### 6.3.2. Test Levels and Performance Criterion

Test Standard

EN 55035:2017+A11:2020

(EN 61000-4-4: 2012)

Open circuit output test voltage and repetition rate of the impulses				
Level	On power port, PE		On I/O (Input/Output) Signal data and control ports	
	Voltage peak KV	Repetition rate KHz	Voltage peak KV	Repetition rate KHz
1.	0.5	5 or 100	0.25	5 or 100
2.	1.0	5 or 100	0.5	5 or 100
3.	2.0	5 or 100	1.0	5 or 100
4.	4.0	5 or 100	2.0	5 or 100
X	Special	Special	Special	Special

Note 1 Use of 5 KHz repetition rates is traditional; however, 100 KHz is closer to reality. Product committees should determine which frequencies are relevant for specific products or product types.

Note 2 With some products, there may be no clear distinction, between power ports and I/O ports, in which case it is up to product committees to make this determination for test purposes.

Note 3 "X" is an open level. The level has to be specified in the dedicated equipment specification.

Performance criterion: **B**





6.3.5. Test Result

Test Point	Polarity	Test Level (kV)	Inject Time (Second)	Inject Method	Performance Criterion	Result (Performance Criterion)
L	±	1	60	Direct	<input type="checkbox"/> A <input checked="" type="checkbox"/> B	A
N	±	1	60	Direct	<input type="checkbox"/> A <input checked="" type="checkbox"/> B	A
PE	±	1	60	Direct	<input type="checkbox"/> A <input checked="" type="checkbox"/> B	A
L+N	±	1	60	Direct	<input type="checkbox"/> A <input checked="" type="checkbox"/> B	A
L+PE	±	1	60	Direct	<input type="checkbox"/> A <input checked="" type="checkbox"/> B	A
N+PE	±	1	60	Direct	<input type="checkbox"/> A <input checked="" type="checkbox"/> B	A
L+N+PE	±	1	60	Direct	<input type="checkbox"/> A <input checked="" type="checkbox"/> B	A

Note 1: The testing performed is from lowest level up to the highest level as required by standard, but only highest level is shown on the report.

Criterion A: Operate as intended during and after the test

Criterion B: Operate as intended after the test

Criterion C: Loss/Error of function

## 6.4. Surges

### 6.4.1. Test Specification

Test Port	:	input a.c. power port
Wave-Shape	:	Open Circuit Voltage - 1.2 / 50 us Short Circuit Current - 8 / 20 us
Pulse Repetition Rate	:	1 pulse / min.
Phase Angle	:	90° / 270°
Test Events	:	5 pulses (positive & negative) for each polarity

### 6.4.2. Test Levels and Performance Criterion

Test Standard

EN 55035:2017+A11:2020

(EN 61000-4-5: 2014)

Severity Level	Open-Circuit Test Voltage KV
1	0.5
2	1.0
3	2.0
4	4.0
*	Special

Performance criterion: **B**

### 6.4.3. Test setup

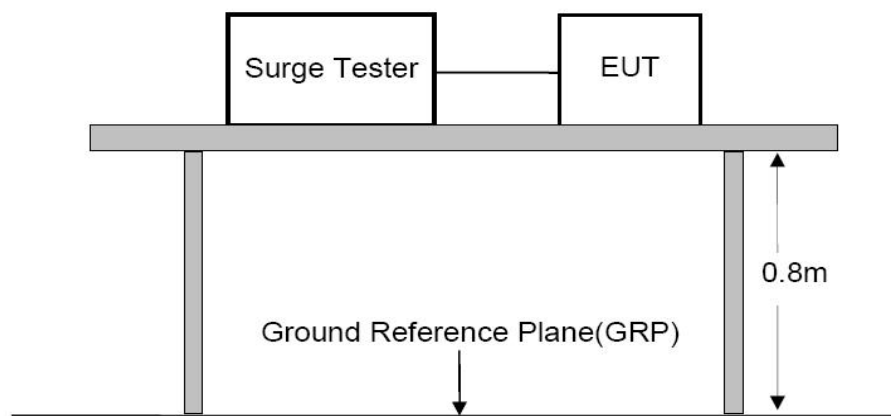



6.4.4. Test Procedure

1. Set up the EUT and test generator as shown on Section 12.1.
2. For line to line coupling mode, provide a 1.0KV 1.2/50us voltage surge (at open-circuit condition) and 8/20us current surge to EUT selected points.
3. Five positive pulses Line-to-neutral at 90°phase, Five negative pulses Line-to-neutral at 270°phase. with a maximum 1/min repetition rate are conducted during test.
4. Different phase angles are done individually.
5. Record the EUT operating situation during compliance test and decide the EUT immunity criterion for above each test.

6.4.5. Test Result

Angle: Positive pulses at 90° phase, Negative pulses at 270° phase						
Inject Line	Polarity	Voltage (kV)	Time Interval (Second)	Inject Method	Performance Criterion	Result (Performance Criterion)
L-N	±	1	60	Direct	<input type="checkbox"/> A <input checked="" type="checkbox"/> B	A
L-PE	±	2	60	Direct	<input type="checkbox"/> A <input checked="" type="checkbox"/> B	A
N-PE	±	2	60	Direct	<input type="checkbox"/> A <input checked="" type="checkbox"/> B	A

Note 1: The testing performed is from lowest level up to the highest level as required by standard, but only highest level is shown on the report.

Criterion A: Operate as intended during and after the test

Criterion B: Operate as intended after the test

Criterion C: Loss/Error of function

### 6.5. Injected currents

#### 6.5.1. Test Specification

Test Port	:	input a.c. power port
Step Size	:	1%
Modulation	:	1kHz, 80% AM
Dwell Time	:	1 second

#### 6.5.2. Test Levels and Performance Criterion

Test Standard

EN 55035:2017+A11:2020

(EN 61000-4-6: 2014)

Frequency ranges MHz	Test level V	Modulation	Performance criterion
0,15 to 80	3	80% AM (1kHz)	A

Performance criterion: **A**

#### 6.5.3. Test setup

CDN Method

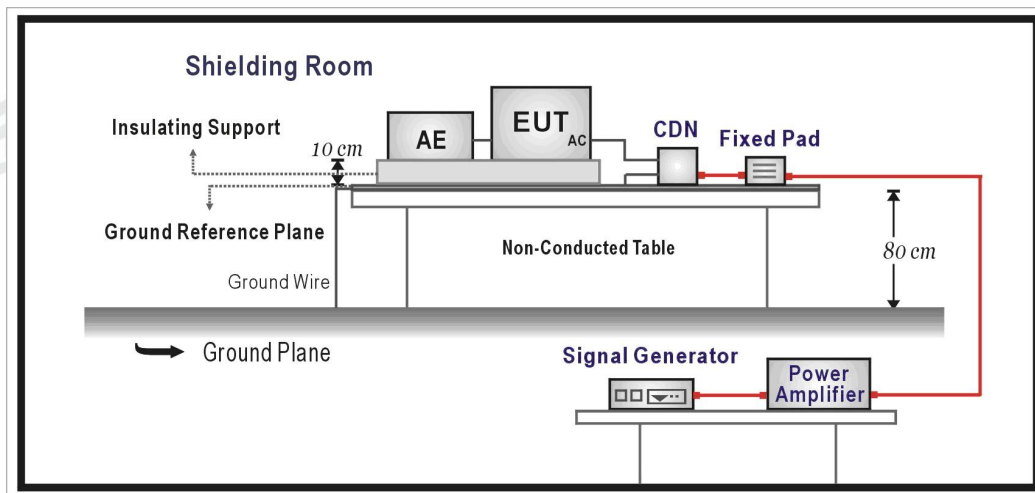

EM Clamp Method

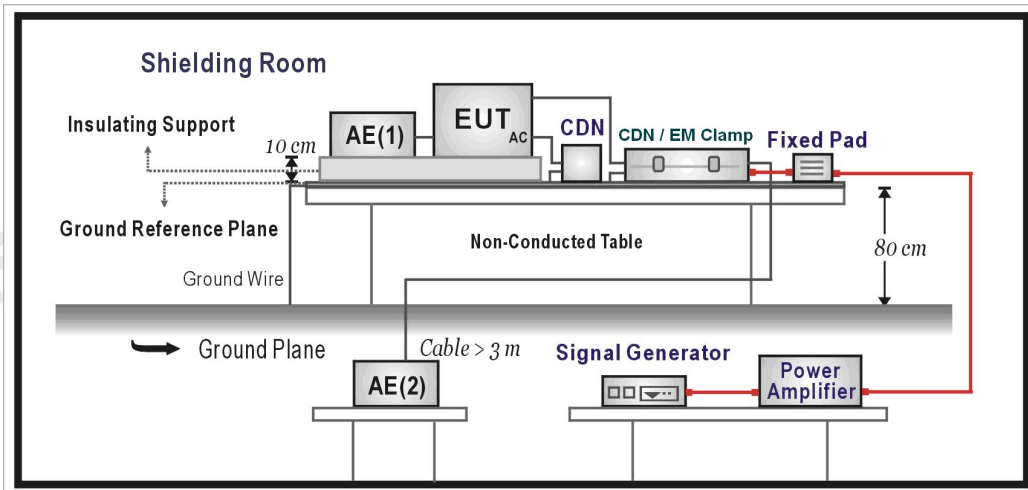

6.5.4. Test Procedure

1. Set up the EUT, CDN and test generators as shown on Section 5.6.1.
2. Let the EUT work in test mode and measure it.
3. The EUT are placed on an insulating support 0.1m high above a ground reference plane. CDN (coupling and decoupling device) is placed on the ground plane about 0.3m from EUT. Cables between CDN and EUT are as short as possible, and their height above the ground reference plane shall be between 30 and 50 mm (where possible).
4. The disturbance signal described below is injected to EUT through CDN.
5. The EUT operates within its operational mode(s) under intended climatic conditions after power on.
6. The frequency range is swept from 150 KHz to 80 MHz using 3V signal level, and with the disturbance signal 80% amplitude modulated with a 1KHz sine wave.
7. The rate of sweep shall not exceed  $1.5 \cdot 10^{-3}$  decades/s. Where the frequency is swept incrementally, the step size shall not exceed 1% of the start and thereafter 1% of the preceding frequency value.
8. Recording the EUT operating situation during compliance testing and decide the EUT immunity criterion.

6.5.5. Test Result

Frequency Band (MHz)	Field Strength (Vrms)	Inject Port	Inject Method	Performance Criterion	Result (Performance Criterion)
0.15 ~ 80	3	AC Mains	CDN	<input checked="" type="checkbox"/> A <input type="checkbox"/> B	A

Note 1: The testing performed is from lowest level up to the highest level as required by standard, but only highest level is shown on the report.

Criterion A: Operate as intended during and after the test

Criterion B: Operate as intended after the test

Criterion C: Loss/Error of function

Note 2: The display quality of a display output was evaluated by using a subjective by direct observation.

**6.6. Power frequency magnetic fields.**

6.6.1. Test Levels and Performance Criterion

Test Standard

EN 55035:2017+A11:2020

(EN 61000-4-8:2010)

Characteristics	Test levels
Field frequency	50/60 Hz
Test level	1 A/m

Performance criterion: **A**

6.6.2. Test setup

For table-top equipment

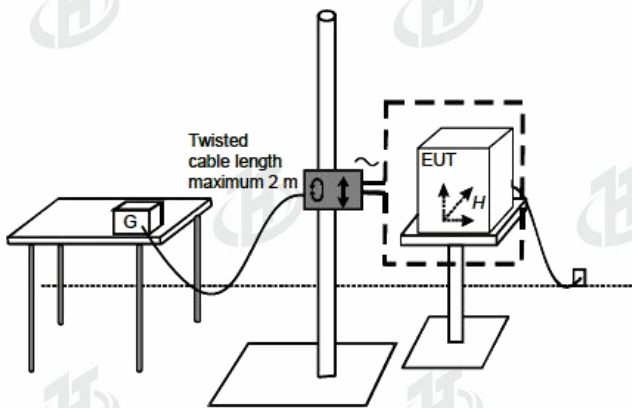

For floor standing equipment

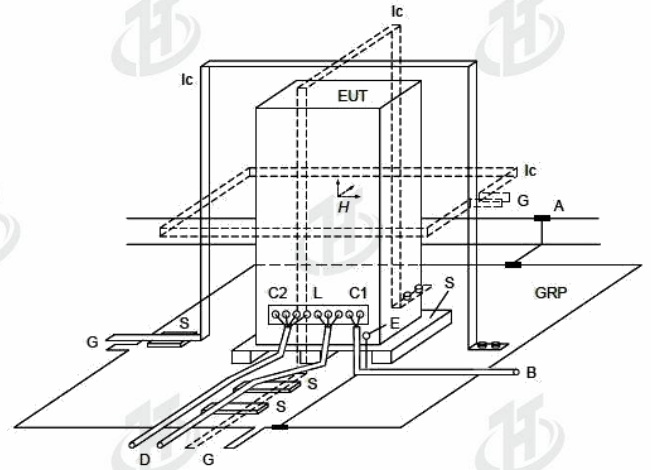

6.6.3. Test Procedure

Measurement was performed in shielded room.

Measurement procedure was applied according to EN 61000-4-8 clause 8.

The test method and equipment was specified by EN 61000-4-8.

6.6.4. Test Result

**N/A**

The product is not a magnetically sensitive device.

## 6.7. Voltage dips and interruptions

### 6.7.1. Test Specification

Test Port	:	input a.c. power port
Phase Angle	:	0°, 180°
Test cycle	:	3 times

### 6.7.2. Test Levels and Performance Criterion

Test Standard

EN 55035:2017+A11:2020

(EN 61000-4-11: 2020)

Test Level %UT	Voltage dip and short interruptions %UT	Duration (in period)
0	100	1
40	60	10
70	30	25
80	20	250
0	100	250

Performance criterion: **A, C, C, C, C**

### 6.7.3. Test setup

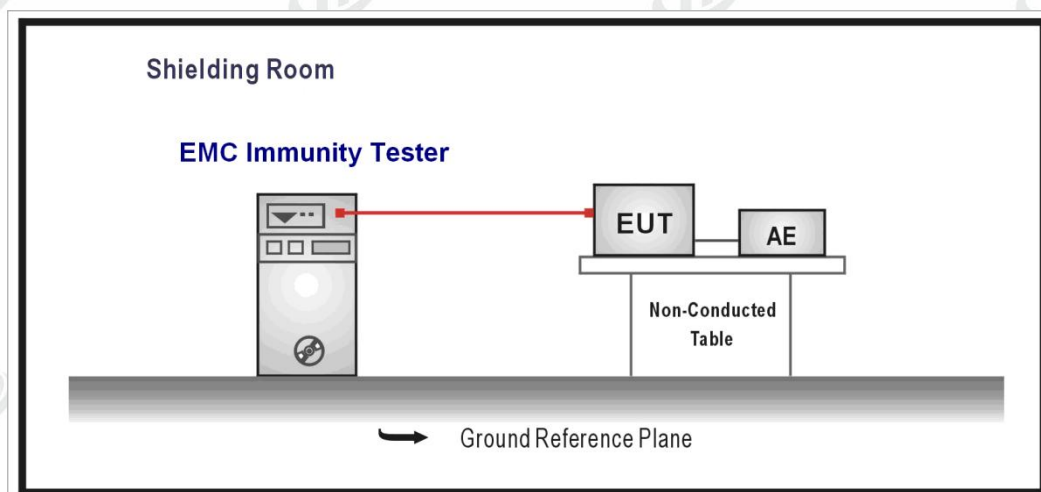



6.7.4. Test Procedure

1. Set up the EUT and test generator as shown on Section 5.7.1.
2. The interruptions is introduced at selected phase angles with specified duration.Record any degradation of performance.

6.7.5. Test Result

Test Voltage (Vac)	Voltage Residual (%)	Test Duration (Periods)	Performance Criterion	Result (Performance Criterion)
230	0	1	<input checked="" type="checkbox"/> A <input type="checkbox"/> B <input type="checkbox"/> C	A
	40	10	<input type="checkbox"/> A <input type="checkbox"/> B <input checked="" type="checkbox"/> C	B
	70	25	<input type="checkbox"/> A <input type="checkbox"/> B <input checked="" type="checkbox"/> C	B
	80	250	<input type="checkbox"/> A <input type="checkbox"/> B <input checked="" type="checkbox"/> C	B
	0	250	<input type="checkbox"/> A <input type="checkbox"/> B <input checked="" type="checkbox"/> C	B

Note 1: The testing performed is from lowest level up to the highest level as required by standard, but only highest level is shown on the report.

Criterion A: Operate as intended during and after the test

Criterion B: Operate as intended after the test

Criterion C: Loss/Error of function

Note2: The power is temporary off and can be reset by the operator.



## 7. Photographs of EUT

EUT Photo 1

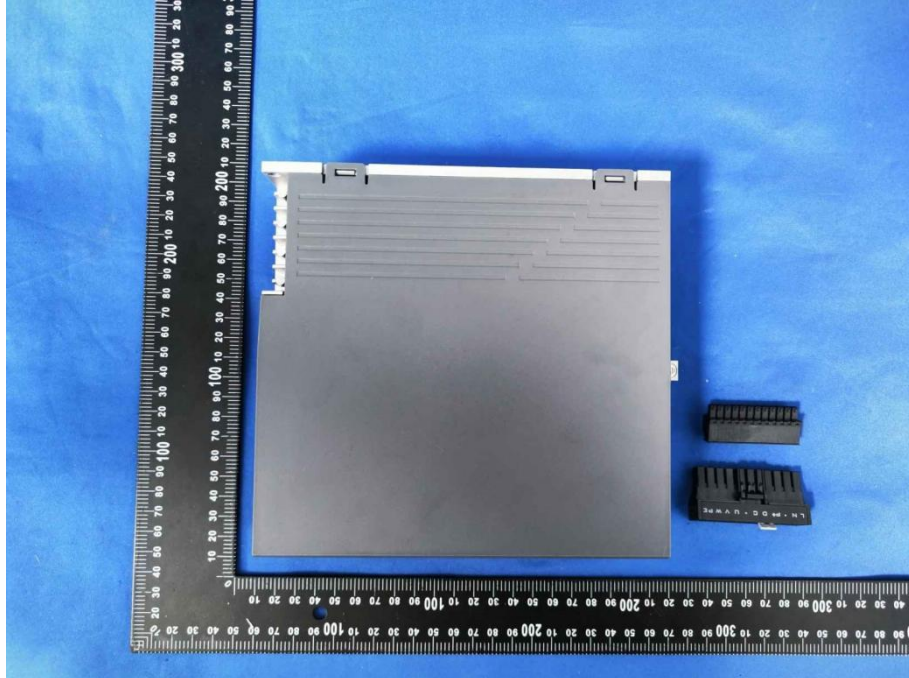

EUT Photo 2

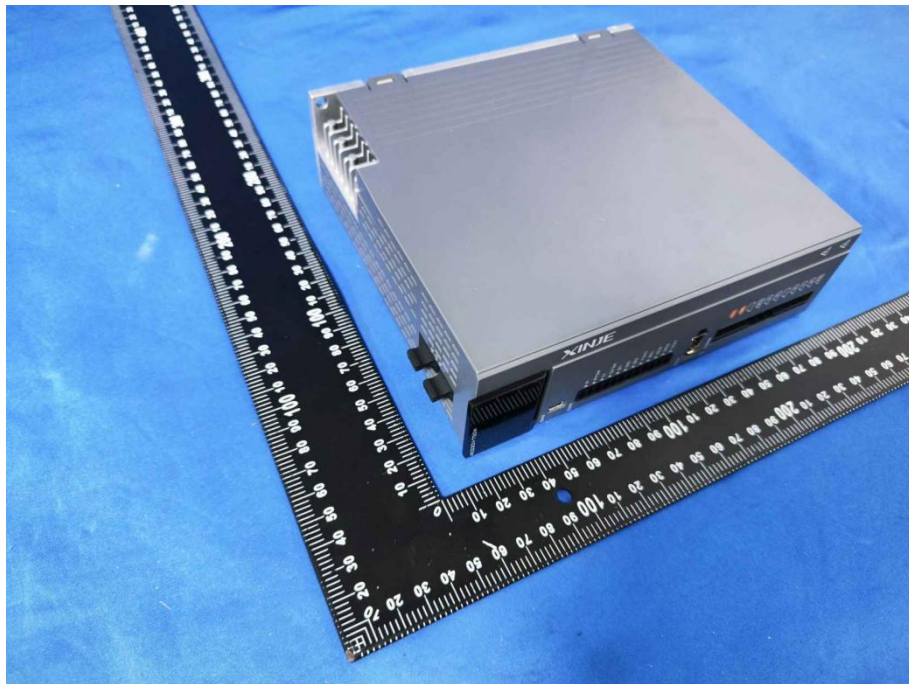



EUT Photo 3

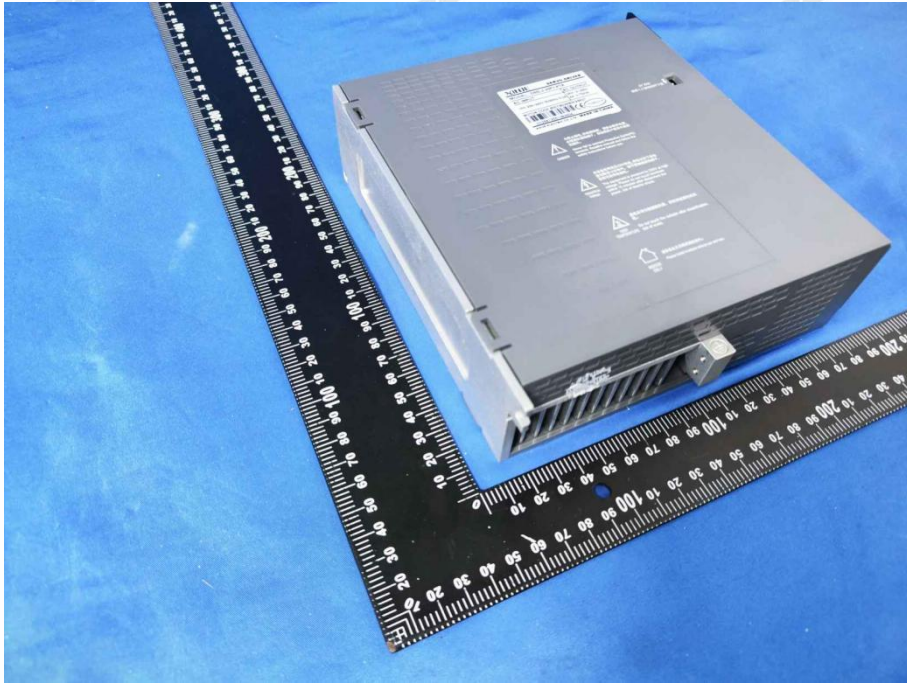

EUT Photo 4





EUT Photo 5

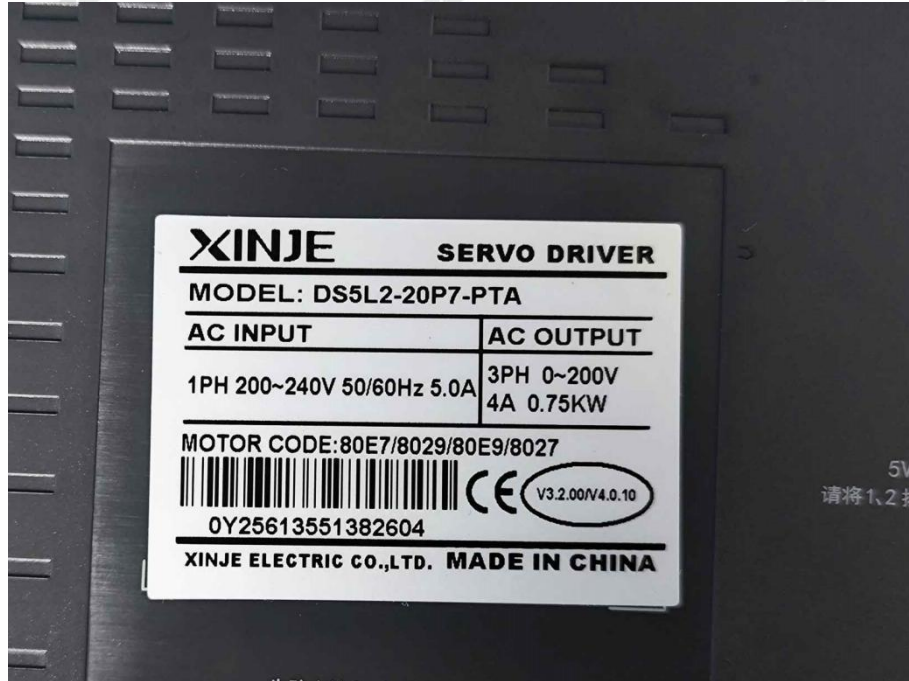

EUT Photo 6

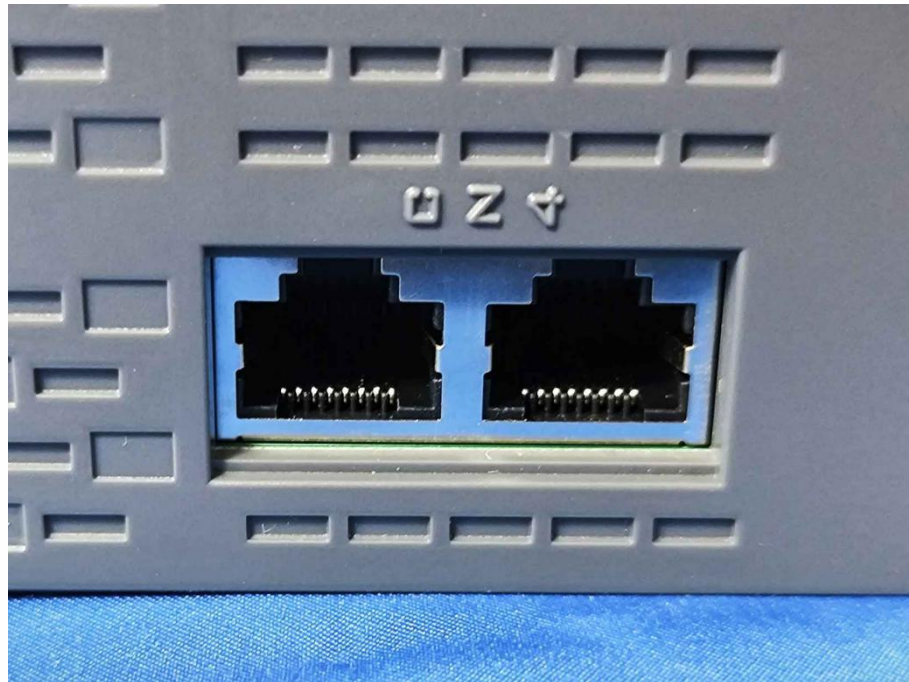



EUT Photo 7

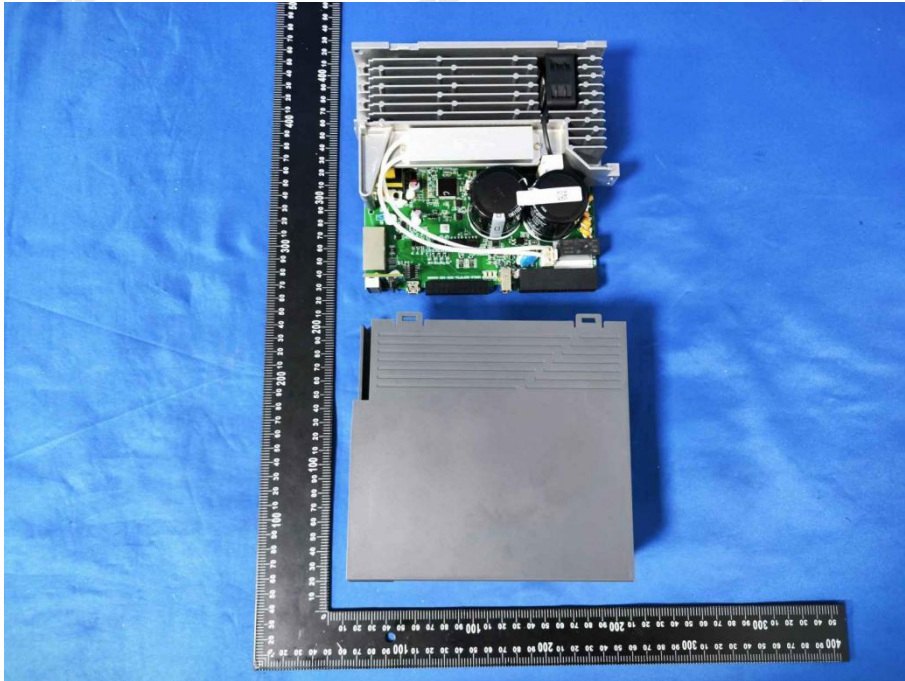

EUT Photo 8

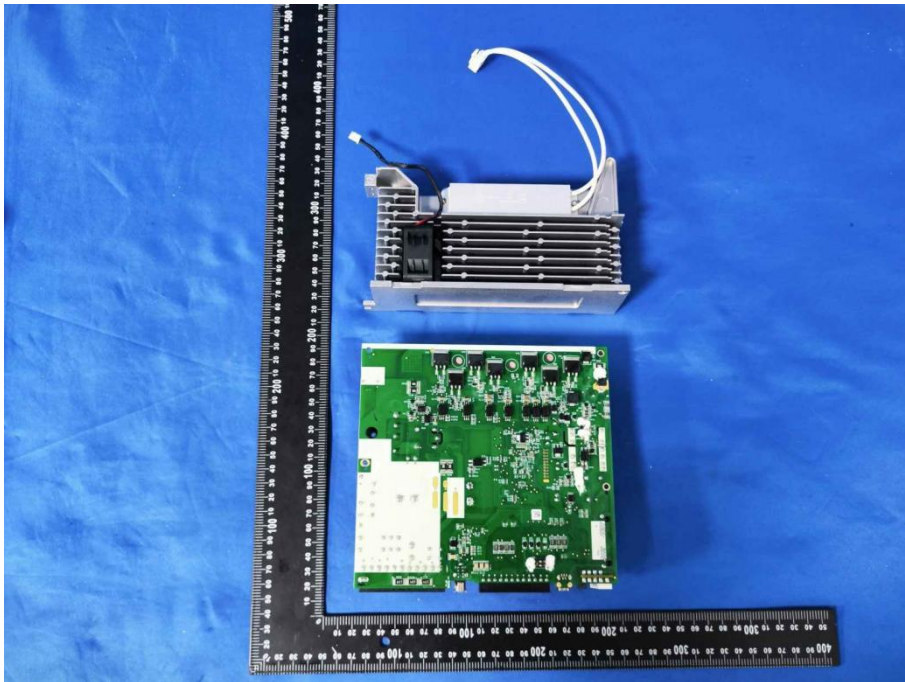



EUT Photo 9

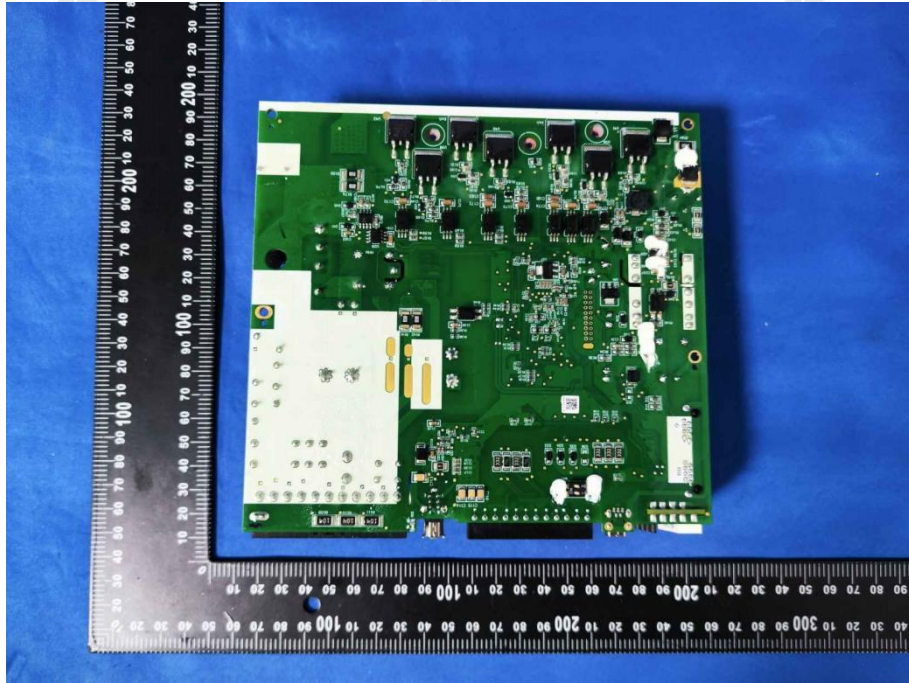

EUT Photo 10

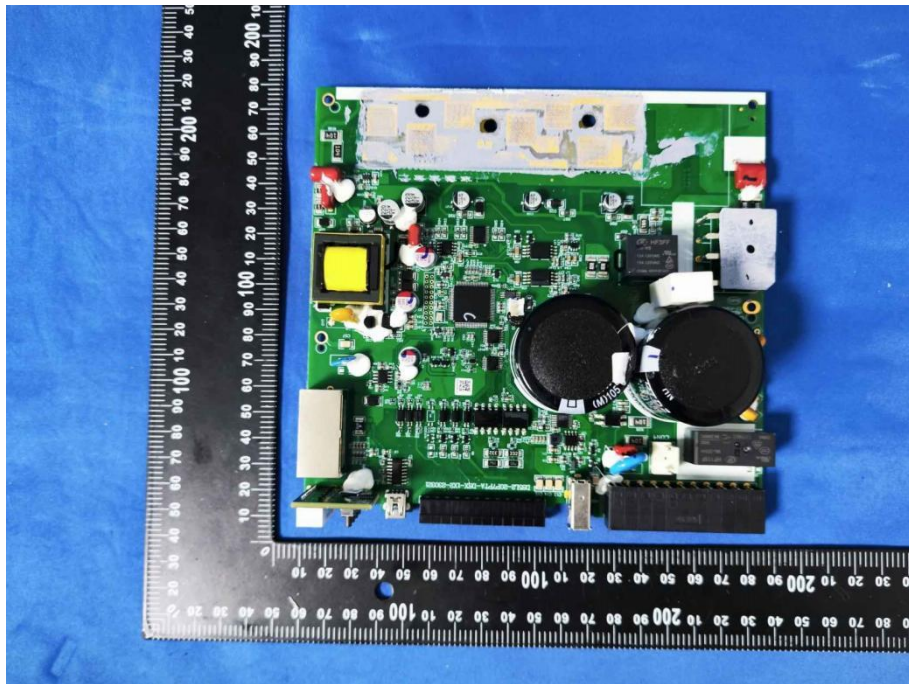



EUT Photo 11

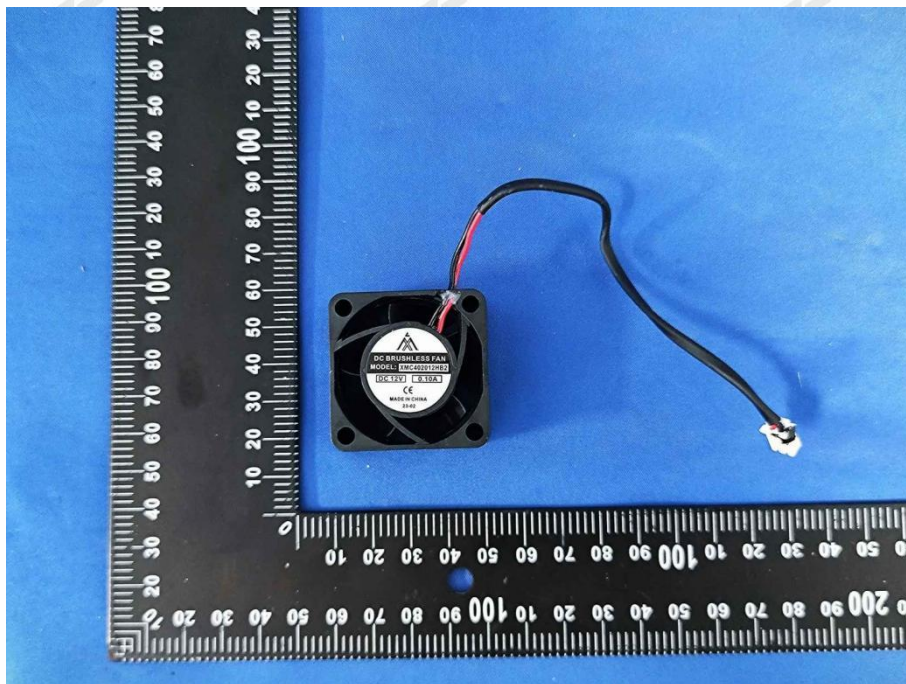

EUT Photo 12

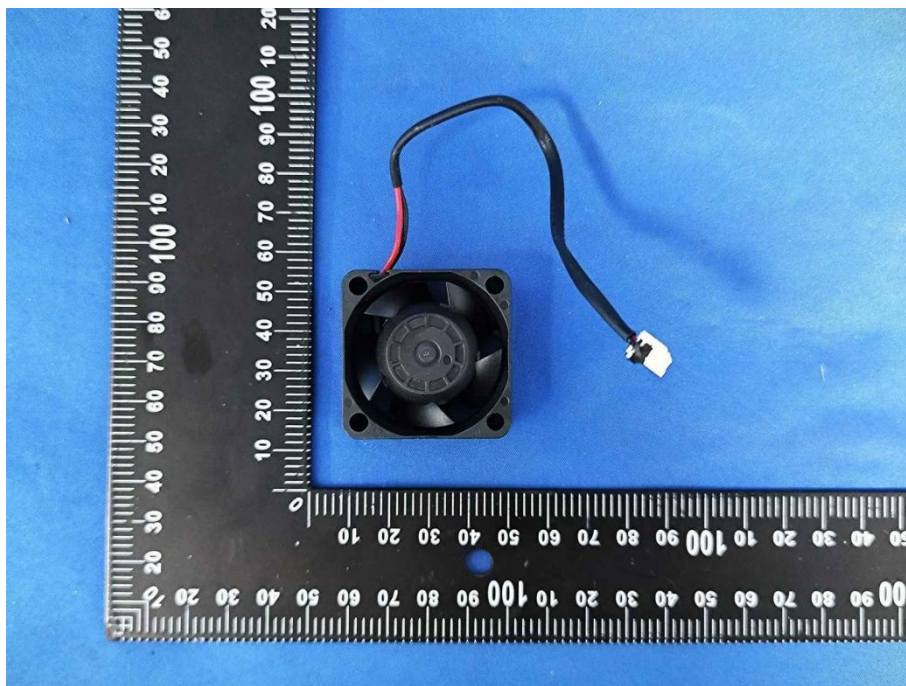

\*\*\*End of report\*\*\*